

SEATED CHORAL RISER SET

NO. 335

SEATING CAPACITY NOT USING THE FLOOR, 30.

SEATING CAPACITY WITH ONE ROW ON THE FLOOR, 39.

SEATING CAPACITY IS BASED ON 26" CHAIR SPACING.

Wenger®

C O R P O R A T I O N

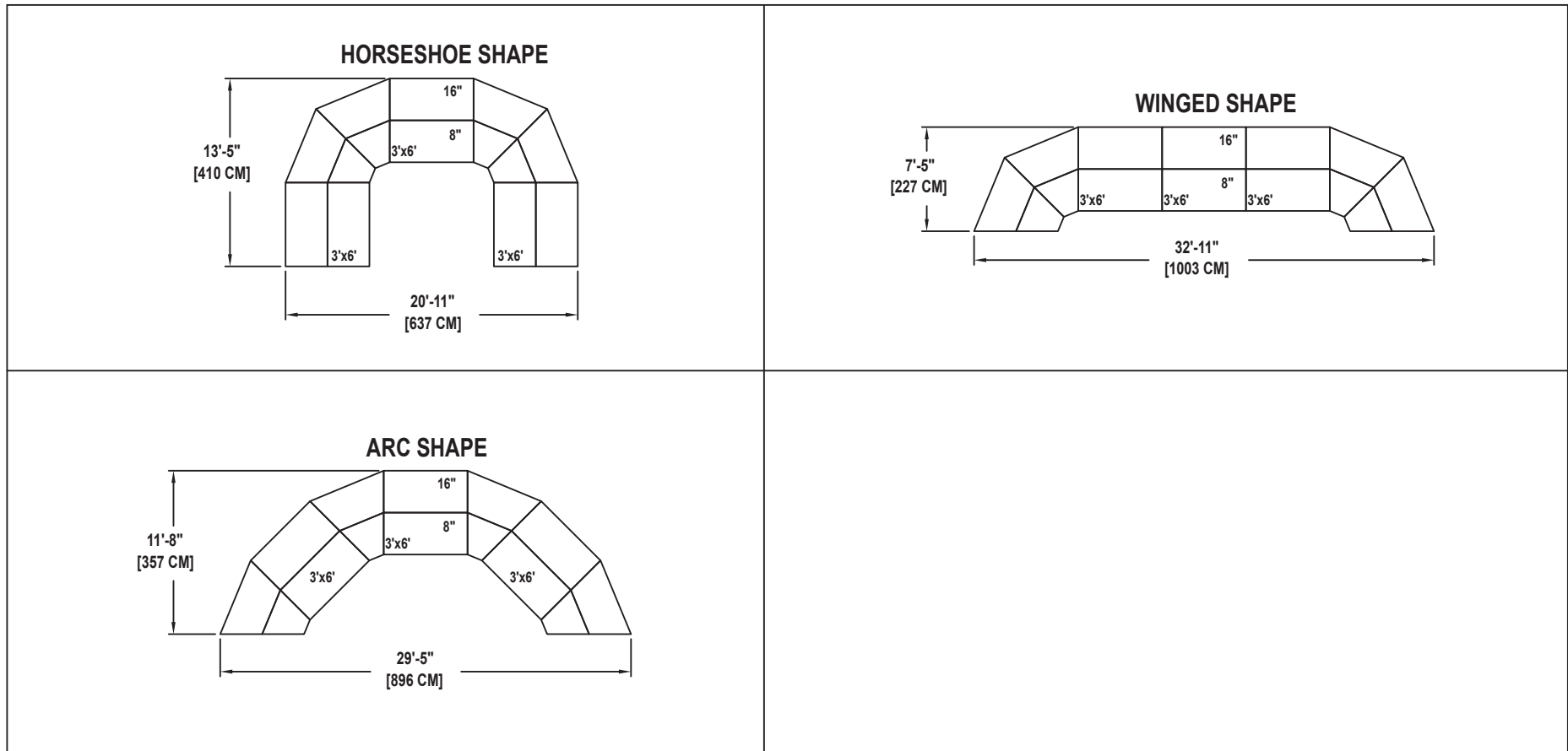

Wenger®

JRCLANCY

GEARBOSS®

Drawing 100A311_A
Sheet 23 of 44



MUSIC EDUCATION AND PERFORMING ARTS

Owatonna Office: Phone 800.4WENGER (493-6437) Worldwide +1.507.455.4100 | Parts & Service 800.887.7145 | wengercorp.com | 555 Park Drive, PO Box 448 | Owatonna | MN 55060-0448

Syracuse Office: Phone 800.836.1885 Worldwide +1.315.451.3440 | jrclancy.com | 7041 Interstate Island Road | Syracuse | NY 13209-9713

ATHLETICS Phone 800.493.6437 | gearboss.com | 555 Park Drive, PO Box 448 | Owatonna | MN 55060-0448